

sanitari
sanitary-ware

lavabi
sinks

vasche
tubs

**piatti e box
doccia**
trays and shower enclosures

rubinetteria
taps

specchi
mirrors

lampade
lamps

accessori
accessories





P	L
70	da 84 cm a 292 cm / from 84 cms to 292 cms
80	
90	

Piatto doccia rettangolare da appoggio in Corian®.
Rectangular top mount Corian® shower tray.



N.B.: Per piatti e box doccia su misura consultare l'Azienda.

P.S.: For shower tray or enclosures in custom sizes consult the Company.

Piatto doccia rettangolare da incasso in Corian®.
Rectangular flush Corian® shower tray.





- 1 Art. **013** L 175 P 80
- 2 Art. **VB7** L 117,5 H 220
- 3 Art. **PEG1** H 220
- 4 Art. **BL602**
- 5 Art. **MIX2**



piatti e box doccia
trays and shower enclosures



- 1 Art. **013** L 175 P 90
- 2 Art. **VB7** L 117,5 H 220
- 3 Art. **PEG1** H 220
- 4 Art. **BL602**
- 5 Art. **MIX3**

- 1 Art. **013T90** L 175 P 90
- 2 Art. **VB7** L 117,5 H 220
- 3 Art. **PEG1** H 220
- 4 Art. **BL601**
- 5 Art. **BL150**
- 6 Art. **MIX3**



piatti e box doccia
trays and shower enclosures



1



piatti e box doccia
trays and shower enclosures

- 1 Art. **013** L 253 P 90
- 2 Art. **VB5** L 97,5 H 220
- 3 Art. **PEG1** H 220
- 4 Art. **BL150**
- 5 Art. **BL603**
- 6 Art. **MIX3**





piatti e box doccia
trays and shower enclosures



1 Art. 013 L 253 P 90

2 Art. VB MISURA SPECIALE / SPECIAL MEASUREMENT
L 177,5 H 220

3 Art. PEG1 H 220

4 Art. BL150

5 Art. BL601

6 Art. MIX21

7 Art. POLE3



piatti e box doccia
trays and shower enclosures

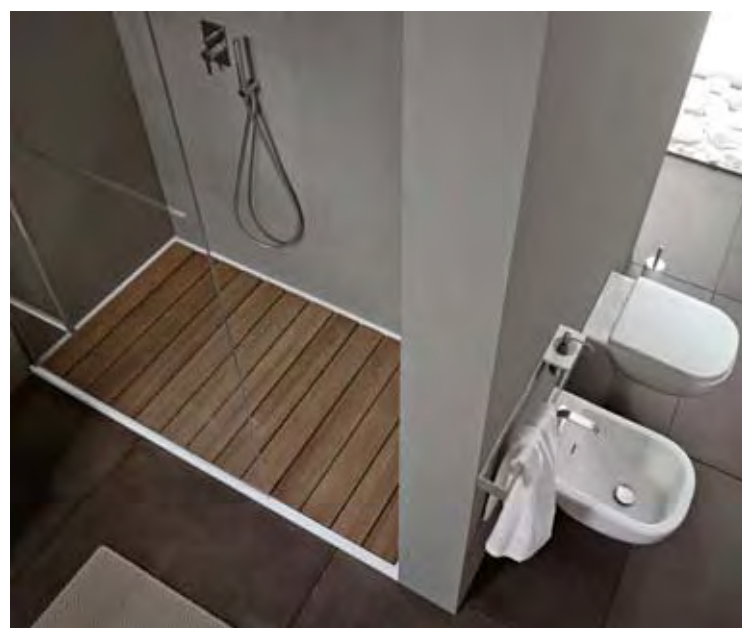
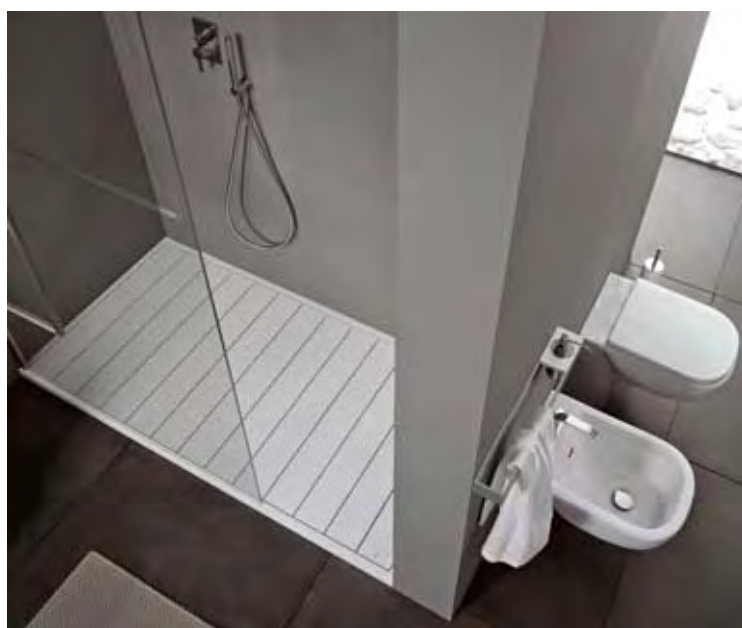

- 1 Art. **01380COMBI** L 175 P 80
Versione dx - *Right version*
- 2 Art. **COMBI120** L 118 H 220
- 3 Art. **BL602**
- 4 Art. **MIX2**



1 Art. **01390COMBI** L 175 P 90
Versione sx - *Left version*

2 Art. **COMBI120** L 118 H 220

3 Art. **BL602**

4 Art. **MIX3**



- 1 Art. **01390COMBI** L 175 P 90
Versione sx - *Left version*
- 2 Art. **COMBI120** L 118 H 220
- 3 Art. **BL150**
- 4 Art. **BL601**
- 5 Art. **MIX3**



- 1 Art. **01380COMBI** L 175 P 80
Versione sx - *Left version*
- 2 Art. **COMBI120** L 118 H 220
- 3 Art. **BL150**
- 4 Art. **BL603**
- 5 Art. **MIX2**



piatti e box doccia
trays and shower enclosures



- 1 Art. **01380COMBI** L 175 P 80
Versione dx - *Right version*
- 2 Art. **COMBI80** L 172,5 P 77,5 H 220
- 3 Art. **BL600**
- 4 Art. **MIX2**





1 Art. **01380COMBI** L 175 P 80
Versione sx - *Left version*

2 Art. **COMBI120** L 118 H 220

3 Art. **BL150**

4 Art. **BL601**

5 Art. **MIX2**



1 Art. **01380COMBI** L 175 P 80
Versione sx - *Left version*

2 Art. **COMBI80** L 172,5 P 77,5 H 220

3 Art. **BL150**

4 Art. **BL601**

5 Art. **MIX2**



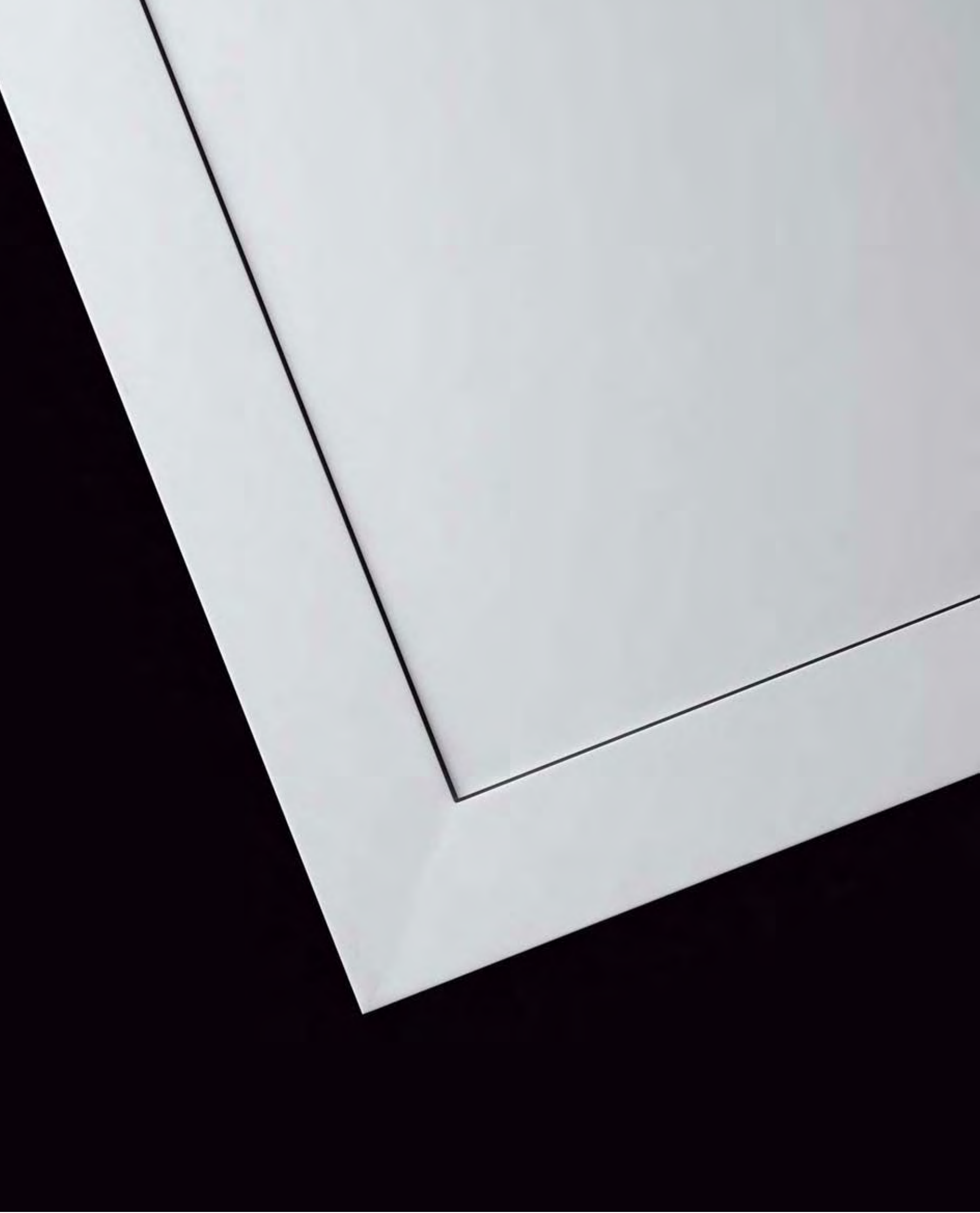



Piatto doccia rettangolare da appoggio in Corian®.
Rectangular top mount Corian® shower tray.



Piatto doccia rettangolare da incasso in Corian®.
Rectangular flush Corian® shower tray.



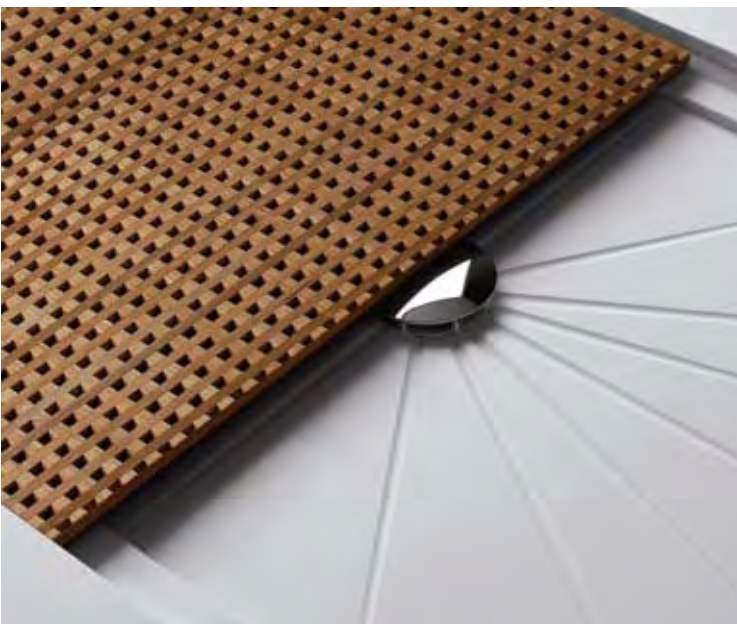



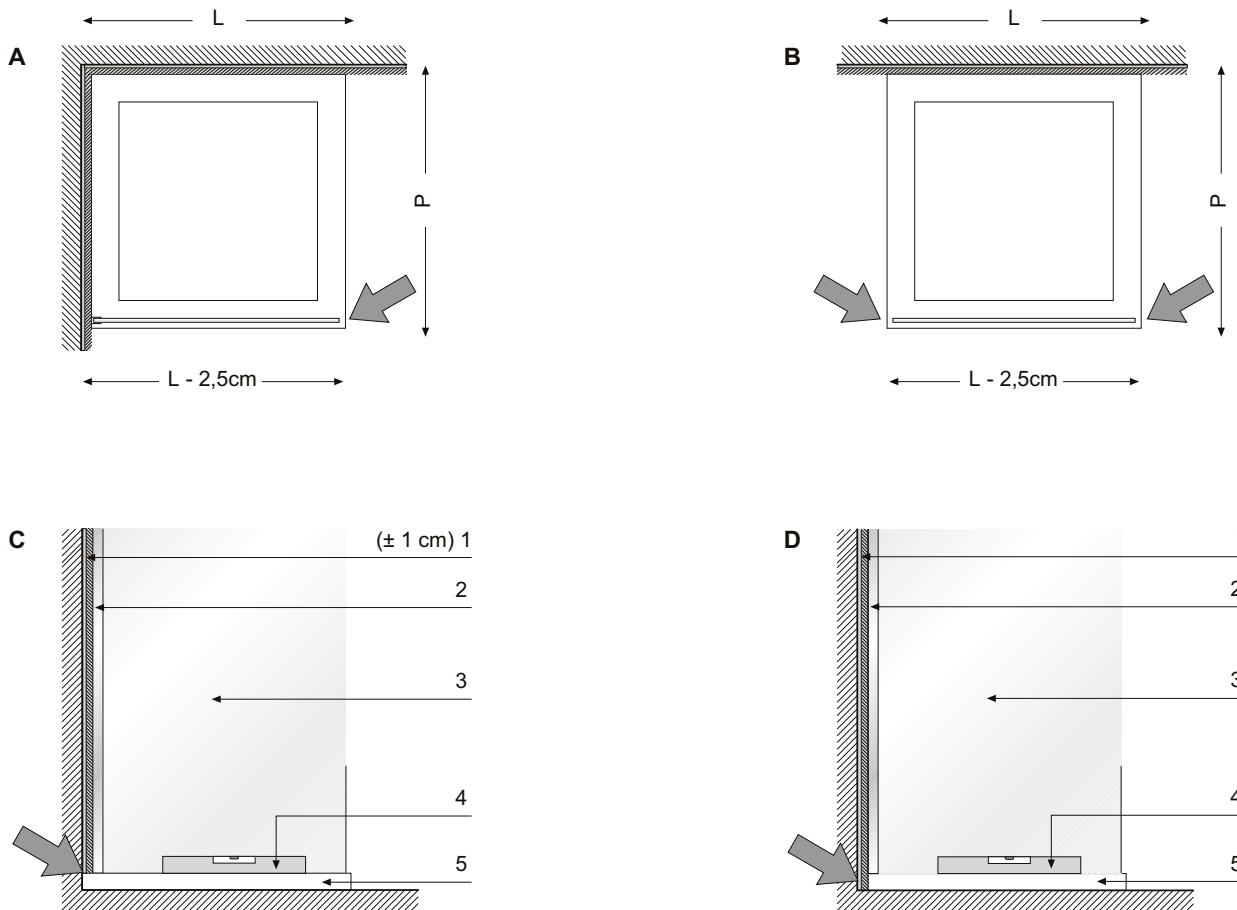

1. Rivestimento / *Tile Coating*
2. Profilo inox / *Stainless profile*
3. Vetro (ridotto di 2,5 cm per lato,rispetto al piatto doccia) / *Glass (reduced by 2,5 cm. on each side with respect to the tray)*
4. Installare il piatto doccia perfettamente in bolla / *Evenly install shower tray*
5. Piatto doccia / *Shower tray*

Tutti i vetri utilizzati nei box doccia sono di spessore 8 mm, temperati, vengono realizzati più corti di 2,5 cm rispetto alla misura del lato piatto doccia (FIG. A e B). I profili e le cerniere impiegati sono in acciaio inox satinato.

La Antonio Lupi Design SpA per ridurre al minimo le possibilità di errore nella trasmissione dell'ordine ed il conseguente invio di articoli non adatti alle vostre esigenze, consiglia di effettuare l'installazione secondo lo schema C (considerando un rivestimento di circa 1 cm), nel caso in cui venga installato secondo lo schema D si prega di trasmettere sempre all'Azienda le misure reali del vano ed eventuali fuori squadra.

Le regole per un corretto rilievo sono le seguenti:

- Segnalare eventuali fuori piombo delle pareti rispetto al pavimento o tra i due muri nel caso di nicchie.
- Per la realizzazione di prodotti su misura si deve sempre fornire un disegno con le indicazioni dell'installazione e le misure dei singoli elementi richiesti.

In caso di ondulazioni o fuori squadra di pareti, la Antonio Lupi Design SpA declina ogni responsabilità per eventuali difficoltà od impossibilità di installazione del prodotto, così come non risponderà per malfunzionamenti o perdite di acqua varie.

All glass utilized for the shower cabins are 8 mm tempered glass, these are made 2,5 cms. shorter than the complete length of the shower tray (FIG. A and B). The wall connectors and hinges are in satin stainless steel.

Antonio Lupi Design SpA. advises installation as shown in drawing C in order to avoid as many mistakes as possible. Considering a tile coating of more or less 1 cm in thickness if installed as in drawing D please always give exact measurements of the shower and eventually any unevenness in the walls or flooring. Follow the instructions below for proper measuring:

- *Highlight any unevenness of the walls with respect to the flooring or between two walls if in a recessed area.*
- *For custom made items always provide a drawing with installation indications and the measurements of each single article.*

In the case of any unevenness in the walls or floor Antonio Lupi Design SpA declines all responsibility for eventual difficulties during installation of the product, such as water leakage or malfunctioning due to such difficulties.

BOX DOCCIA A MISURA

E' consentito realizzare piatti e box doccia su misura, per il prezzo e la fattibilità consultare l'azienda.

CUSTOM MADE SHOWER CABINS

For custom made shower cabins and trays please consult the company.

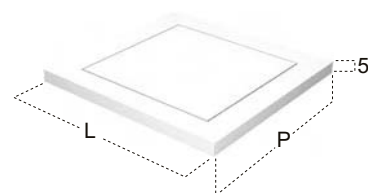
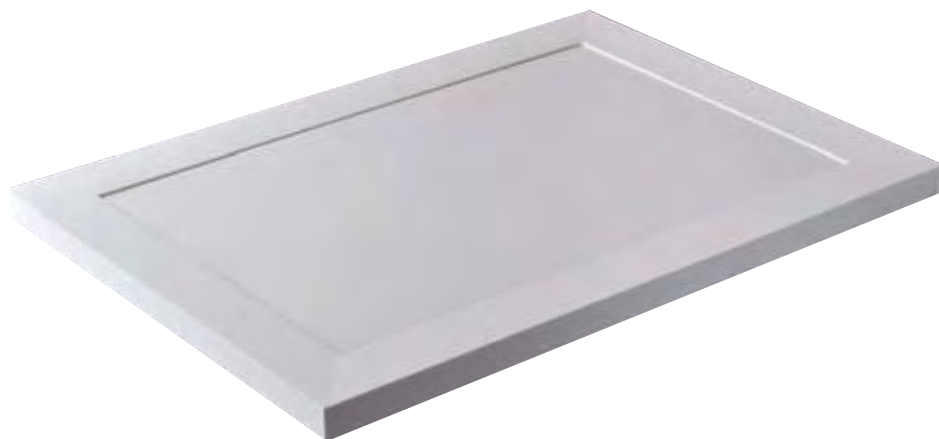

H	L	P	art.
5	90	70	SLAB1
	80	80	SLAB2
	90	90	SLAB3
	110	80	SLAB4

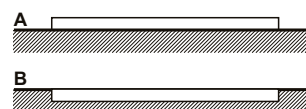

Piatto doccia in Corian® quadrato o rettangolare da appoggio (A) o da incasso (B) con pedana removibile completa di sifone.
Square or rectangular shower tray and removable footboard completely in Corian® top mount (A) or flush (B) complete with trap.

piatti e box doccia
trays and shower enclosures

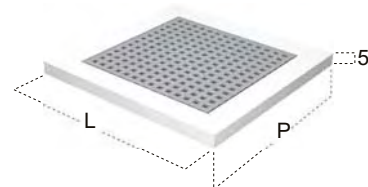
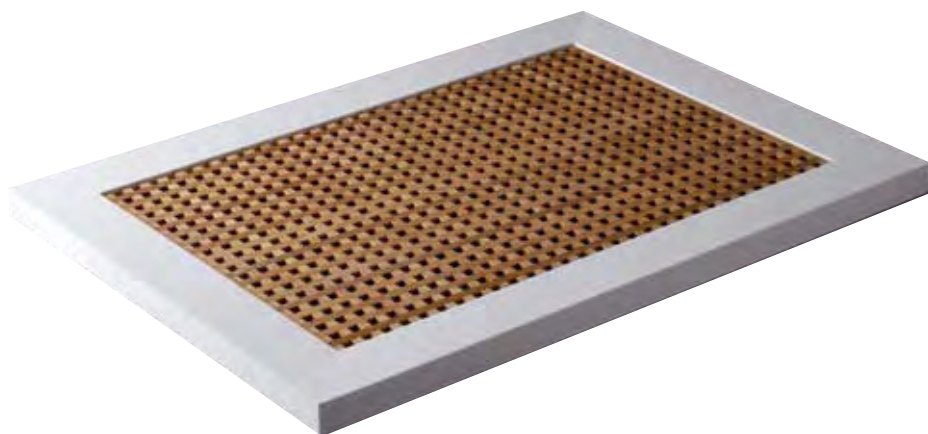

H	L	P	art.
5	90	70	SLAB21
	80	80	SLAB22
	90	90	SLAB23
	110	80	SLAB24

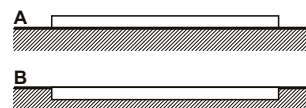

Piatto doccia in Corian® quadrato o rettangolare, da appoggio (A) o da incasso (B), con pedana removibile a carabottino in Teak, completo di sifone.
Square or rectangular shower tray in Corian® top mount (A) or flush (B) complete with removable braided Teak footboard and trap.



- art. 01370 P. 70
- art. 01380 P. 80
- art. 01390 P. 90

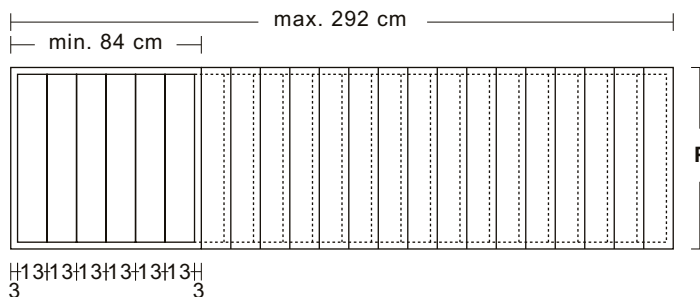

H	L	*	Larghezza : 2 - Length / 2
3,7	84	*	Larghezza : 2 - Length / 2
	97	*	Larghezza : 2 - Length / 2
	110	*	Larghezza : 2 - Length / 2
	123	*	Larghezza : 2 - Length / 2
	136	*	Larghezza : 2 - Length / 2
	149	*	Larghezza : 2 - Length / 2
	162	**	Larghezza : 3 - Length / 3
	175	**	Larghezza : 3 - Length / 3
	188	**	Larghezza : 3 - Length / 3
	201	**	Larghezza : 3 - Length / 3
	214	**	Larghezza : 3 - Length / 3
	227	**	Larghezza : 3 - Length / 3
	240	**	Larghezza : 3 - Length / 3
	253	**	Larghezza : 3 - Length / 3
	266	**	Larghezza : 3 - Length / 3
	279	**	Larghezza : 3 - Length / 3
	292	**	Larghezza : 3 - Length / 3

- * N° 01 Scarico centrale (Larghezza diviso 2)
N° 01 Central drain (Length divided by 2)
- ** N° 02 Scarichi (Larghezza diviso 3)
N° 02 Drains (Length divided by 3)

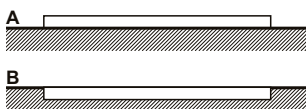

Piatto doccia rettangolare da appoggio (A) o da incasso (B) completo di sifone con pedana in Corian® composta da doghe L. 13 cm removibili.

N.B.: La larghezza del piatto doccia è determinata dalla moltiplicazione del numero delle doghe per 13 cm più 6 cm di bordo. Esempio: 84 cm = (n° 6 doghe x 13 cm) + 6 cm. La larghezza dei piatti doccia è realizzabile anche a misura, per il prezzo utilizzare la misura superiore. Esempio: Larghezza desiderata 170 cm, fare riferimento alla misura di 175 cm.

ATTENZIONE: Il fuori misura verrà equamente distribuito sulle due doghe più esterne.

Rectangular top mount (A) or flush (B) Corian® shower tray complete with trap; footboard made of removable slabs 13 cms.L.

P.S.: The length of the shower tray is determined by the multiplication of the slabs by 13 cms. plus 6 cms. for the border. Example: 84 cms. = (n° 6 slabs x 13 cms.) + 6 cms. Special measures are also available for the price reference the superior measurement. Example: Length desired is 170 cms. reference the price for the length 175 cms.

WARNING: Custom sizes will have the outer two slabs in equal sizes.

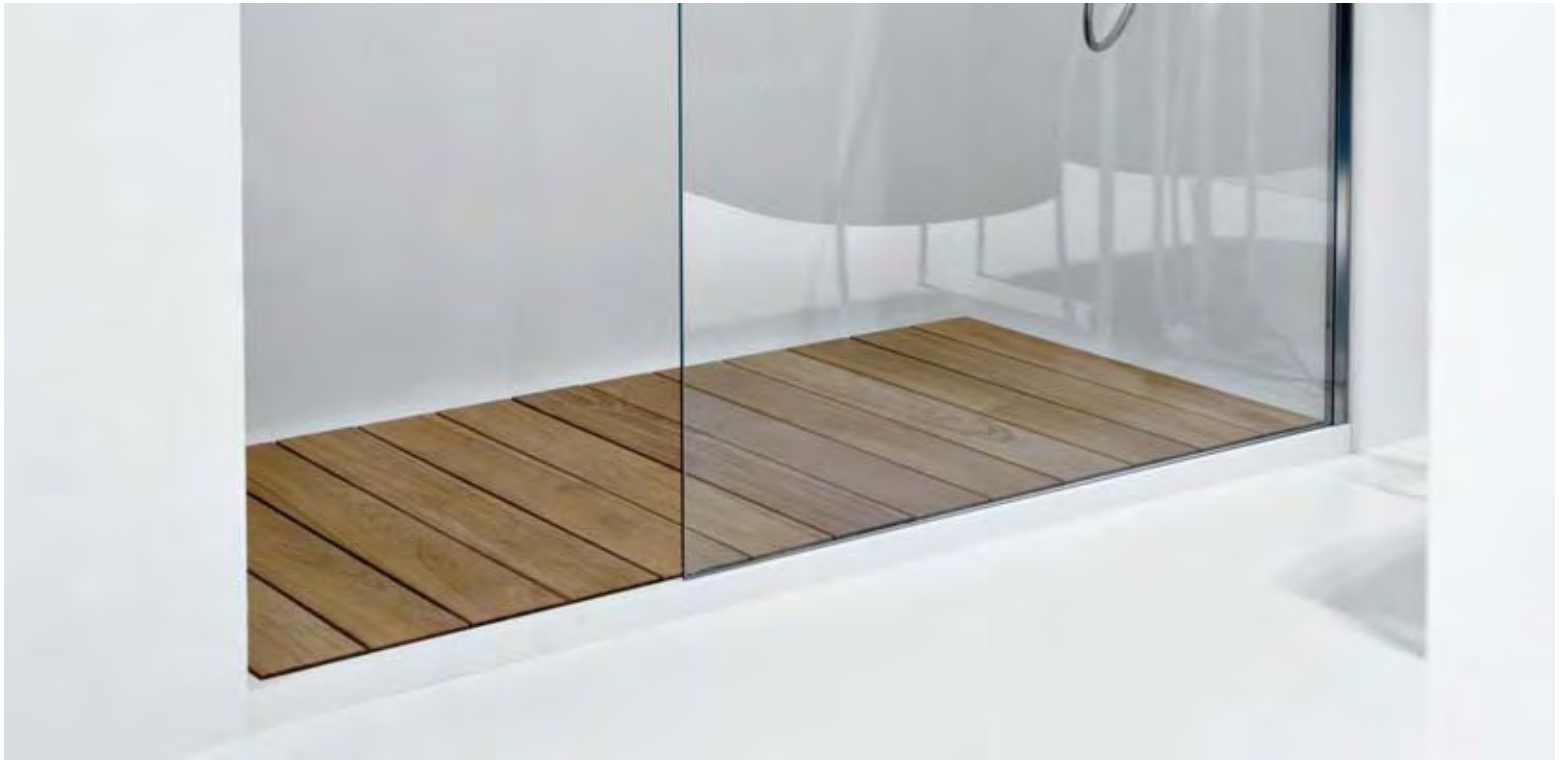

- art. 013T70 P. 70
- art. 013T80 P. 80
- art. 013T90 P. 90

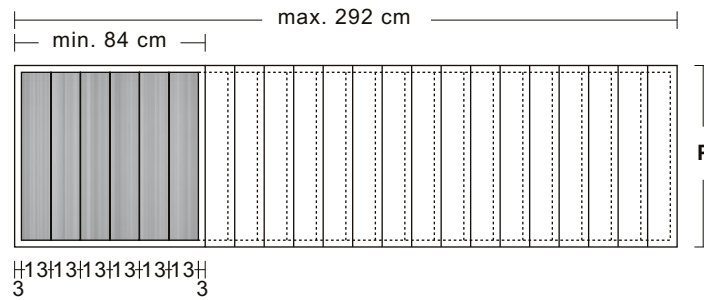

H	L		
3,7	84	*	Larghezza : 2 - Length / 2
	97	*	Larghezza : 2 - Length / 2
	110	*	Larghezza : 2 - Length / 2
	123	*	Larghezza : 2 - Length / 2
	136	*	Larghezza : 2 - Length / 2
	149	*	Larghezza : 2 - Length / 2
	162	**	Larghezza : 3 - Length / 3
	175	**	Larghezza : 3 - Length / 3
	188	**	Larghezza : 3 - Length / 3
	201	**	Larghezza : 3 - Length / 3
	214	**	Larghezza : 3 - Length / 3
	227	**	Larghezza : 3 - Length / 3
	240	**	Larghezza : 3 - Length / 3
	253	**	Larghezza : 3 - Length / 3
	266	**	Larghezza : 3 - Length / 3
	279	**	Larghezza : 3 - Length / 3
	292	**	Larghezza : 3 - Length / 3

- * N° 01 Scarico centrale (Larghezza diviso 2)
N° 01 Central drain (Length divided by 2)
- ** N° 02 Scarichi (Larghezza diviso 3)
N° 02 Drains (Length divided by 3)

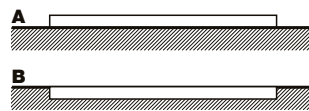

Piatto doccia rettangolare da appoggio (A) o da incasso (B) in Corian® completo di sifone con pedana in teak composta da doghe L. 13 cm removibili.
N.B.: La larghezza del piatto doccia è determinata dalla moltiplicazione del numero delle doghe per 13 cm più 6 cm di bordo. Esempio: 84 cm = (n° 6 doghe x 13 cm) + 6 cm. La larghezza dei piatti doccia è realizzabile anche a misura, per il prezzo utilizzare la misura superiore. Esempio: Larghezza desiderata 170 cm, fare riferimento alla misura di 175 cm.

ATTENZIONE: Il fuori misura verrà equamente distribuito sulle due doghe più esterne.

Rectangular top mount (A) or flush (B) Corian® shower tray complete with trap; footboard made of removable Teak slabs 13 cms.L.

P.S.: The length of the shower tray is determined by the multiplication of the slabs by 13 cms. plus 6 cms. for the border. Example: 84 cms. = (n° 6 slabs x 13 cms.) + 6 cms. Special measures are also available for the price reference the superior measurement. Example: Length desired is 170 cms. reference the price for the length 175 cms.
WARNING: Custom sizes will have the outer two slabs in equal sizes.



H	L	art.
195	57,5	VB11
	67,5	VB12
	77,5	VB13
	87,5	VB14
	97,5	VB15
	107,5	VB16
	117,5	VB17
220	57,5	VB1
	67,5	VB2
	77,5	VB3
	87,5	VB4
	97,5	VB5
	107,5	VB6
	117,5	VB7

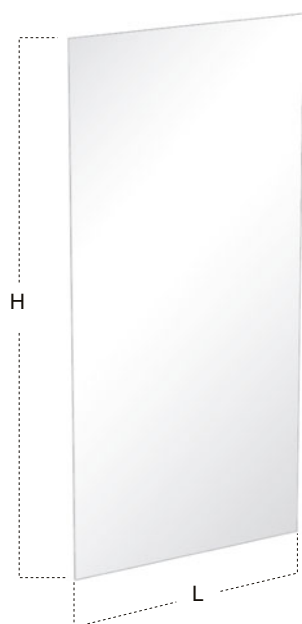

Vetro temperato spess. 8 mm per piatti doccia.
N.B.: Su richiesta si eseguono anche vetri a misura.

*8 mm. tempered glass for shower trays.
P.S.: Custom made sizes upon request.*



cristallo extrachiario
ultra clear glass



cristallo trasparente
transparent glass



cristallo acidato
acid glass



MIX design AL Studio

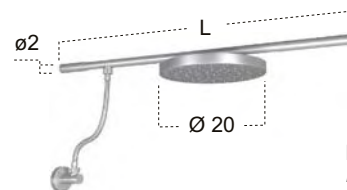

Per piatti doccia
For shower trays

L	013COMBI P	art.
66,7	70	MIX1
76,7	80	MIX2
86,7	90	MIX3
96,7	100	MIX4
106,7	110	MIX5

Soffione cromo lucido con asta distanziale per vetri box doccia completo di presa a parete con flessibile 60 cm in acciaio inox satinato.

Polished chrome overhead shower with bar for glass shower cabins complete with wall connector and flexible hose cms. 60.



POLE design AL Studio

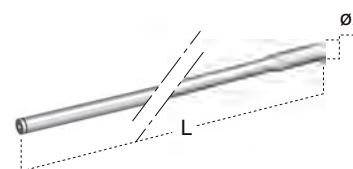

Per piatti doccia
For shower trays

L	013COMBI P	art.
66,7	70	POLE1
76,7	80	POLE2
86,7	90	POLE3
96,7	100	POLE4
106,7	110	POLE5

Asta distanziale per vetri box doccia in acciaio inox satinato.

Satin stainless steel shower bar for glass shower cabins.



PEG design Nevio Tellatin

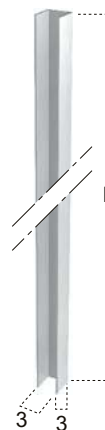

H	art.
195	PEG2
220	PEG1

Profilo in acciaio inox satinato per il fissaggio a parete dei vetri box doccia.

Glass wall fixing profiles in satin stainless steel for shower cabins.



piatti e box doccia
trays and shower enclosures





Versione sx - Left version



Versione dx - Right version

- art. 01370COMBI P. 70
- art. 01380COMBI P. 80
- art. 01390COMBI P. 90

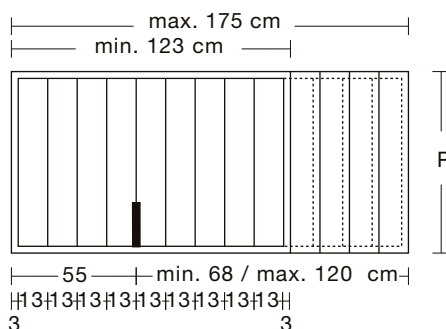

H	L	*	Larghezza : 2 - Length / 2
3,7	123	*	Larghezza : 2 - Length / 2
	136	*	Larghezza : 2 - Length / 2
	149	*	Larghezza : 2 - Length / 2
	162	**	Larghezza : 3 - Length / 3
	175	**	Larghezza : 3 - Length / 3

- * N° 01 Scarico centrale (Larghezza diviso 2)
N° 01 Central drain (Length divided by 2)
- ** N° 02 Scarichi (Larghezza diviso 3)
N° 02 Drains (Length divided by 3)

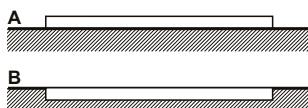

Piatto doccia rettangolare da appoggio (A) o da incasso (B) completo di sifone con pedana in Corian® composta da doghe L. 13 cm removibili.

N.B.: La larghezza del piatto doccia è determinata dalla moltiplicazione del numero delle doghe per 13 cm più 6 cm di bordo. Esempio: 123 cm = (n° 9 doghe x 13 cm) + 6 cm. La larghezza dei piatti doccia è realizzabile anche a misura. Per il prezzo utilizzare la misura superiore. Esempio: larghezza desiderata 170 cm, fare riferimento alla misura di 175 cm. **ATTENZIONE:** Il fuori misura verrà distribuito sulle due doghe opposte all'entrata del piatto doccia.

Rectangular top mount (A) or flush (B) Corian® shower tray complete with trap; footboard made of removable slabs 13 cms. L.

P.S.: The length of the shower tray is determined by the multiplication of the slabs by 13 cms. plus 6 cms. for the border.

Example: 123 cms. = (n° 9 slabs x 13 cms.) + 6 cms.

Special measures are also available.

WARNING: Special sizes will be distributed amongst the last two opposite the entrance.



art. COMBI70	H195	P. 70
art. COMBI80	H195	P. 80
art. COMBI90	H195	P. 90
art. COMBI170	H220	P. 70
art. COMBI180	H220	P. 80
art. COMBI190	H220	P. 90

		Per piatti doccia For shower trays	
P	L	013COMBI P	L
67,5	120,5	70	123
	133,5		136
	146,5		149
	159,5		162
	172,5		175
77,5	120,5	80	123
	133,5		136
	146,5		149
	159,5		162
	172,5		175
87,5	120,5	90	123
	133,5		136
	146,5		149
	159,5		162
	172,5		175

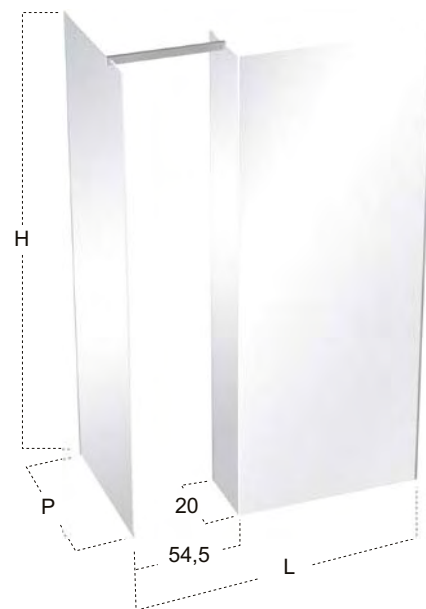

Versione sx - Left version

Box doccia dx o sx in vetro temperato spess. 8 mm per piatto doccia Art. 013COMBI tra pareti in **angolo**, completo di profilo a parete e distanziale in acciaio inox satinato.
N.B.: Su richiesta si eseguono anche vetri a misura.

Right or left shower enclosure in 8 mm tempered glass for shower tray Art. Art. 013COMBI in a corner complete with wall profile and satin stainless steel bar.

P.S.: Custom made sizes upon request.

Cristallo trasparente Cristallo extrachiario Cristallo acidato
Transparent glass Ultra clear glass Acid glass



art. COMBI20 H. 195
art. COMBI120 H. 220



Versione sx - Left version

Cristallo trasparente Cristallo extrachiario Cristallo acidato
Transparent glass Ultra clear glass Acid glass

Per piatti doccia
For shower trays

L	013COMBI	L
66		123
79		136
92		149
105		162
118		175

Box doccia dx o sx in vetro temperato spess. 8 mm per piatto doccia Art. 013COMBI tra pareti in nicchia, completo di profilo a parete.
N.B.: Su richiesta si eseguono anche vetri a misura.

Right or left shower enclosure in 8 mm tempered glass for shower tray Art. 013COMBI in a recessed area complete with wall profiles.

P.S.: Custom made sizes upon request.

ORNÉ

design Riccardo Fattori

I vetri utilizzati nei box doccia, in cristallo trasparente o cristallo extrachiaro, possono essere realizzati esternamente con decori in Duroglass. Alcuni possono avere motivi in positivo, codificato art...../P o in negativo, codificato art...../N.
Per calcolare il prezzo finale di un vetro bisogna sommare al prezzo della misura e finitura desiderata, il costo per la realizzazione del motivo in positivo o in negativo.

The glass used for the shower cabins either in clear glass or extra-clear glass, can be made with a "Duroglass" motif on the external side. Some of these can be in positive, with art. code /P or in negative with art. code /N. To calculate the final price of a shower glass, you must reference the price of the glass in the measurement and finish desired and add the cost of the motif in either positive or negative.

esempio/example

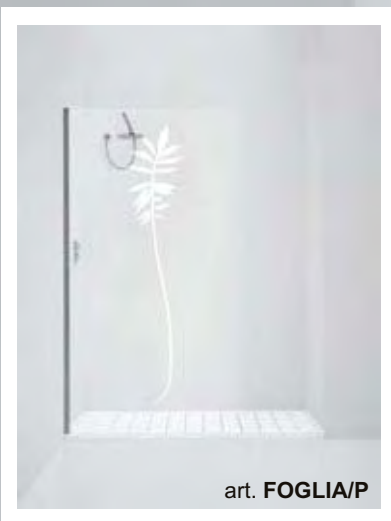



piatti e box doccia
trays and shower enclosures





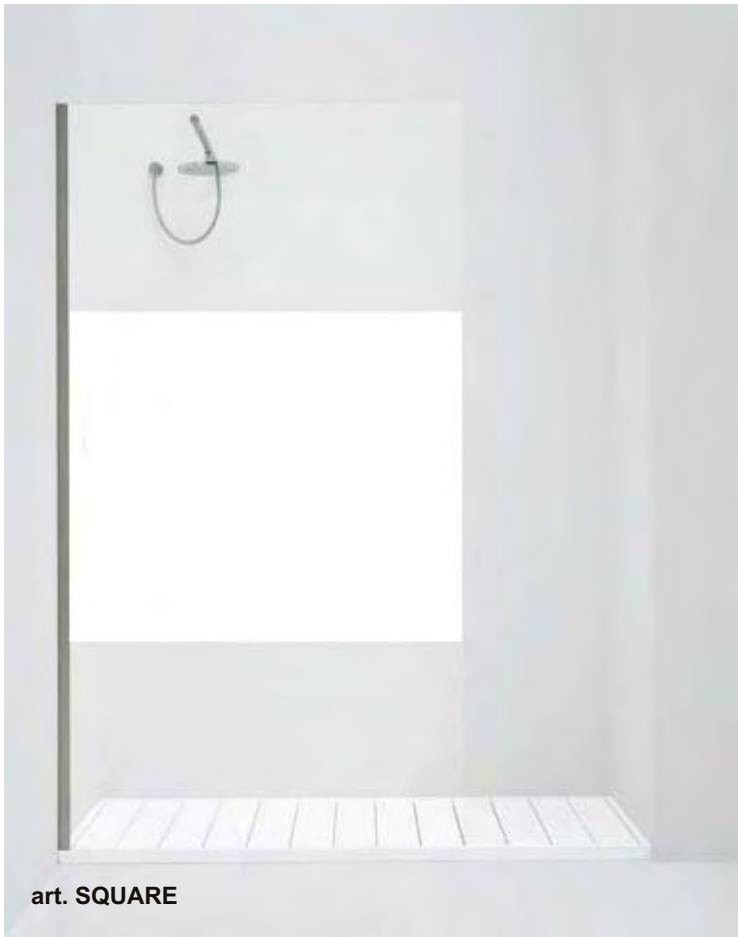

art. SQUARE



art. FABRIC



art. BARCODE



art. LABIRINTO



art. FOGLIA/N DOWN



art. FOGLIA/P UP





piatti e box doccia
trays and shower enclosures







art. RIGATO



art. RIGATO CORNICE



art. BAMBÙ



art. MOSAICO sx



art. MALE/N



art. FEMALE/N

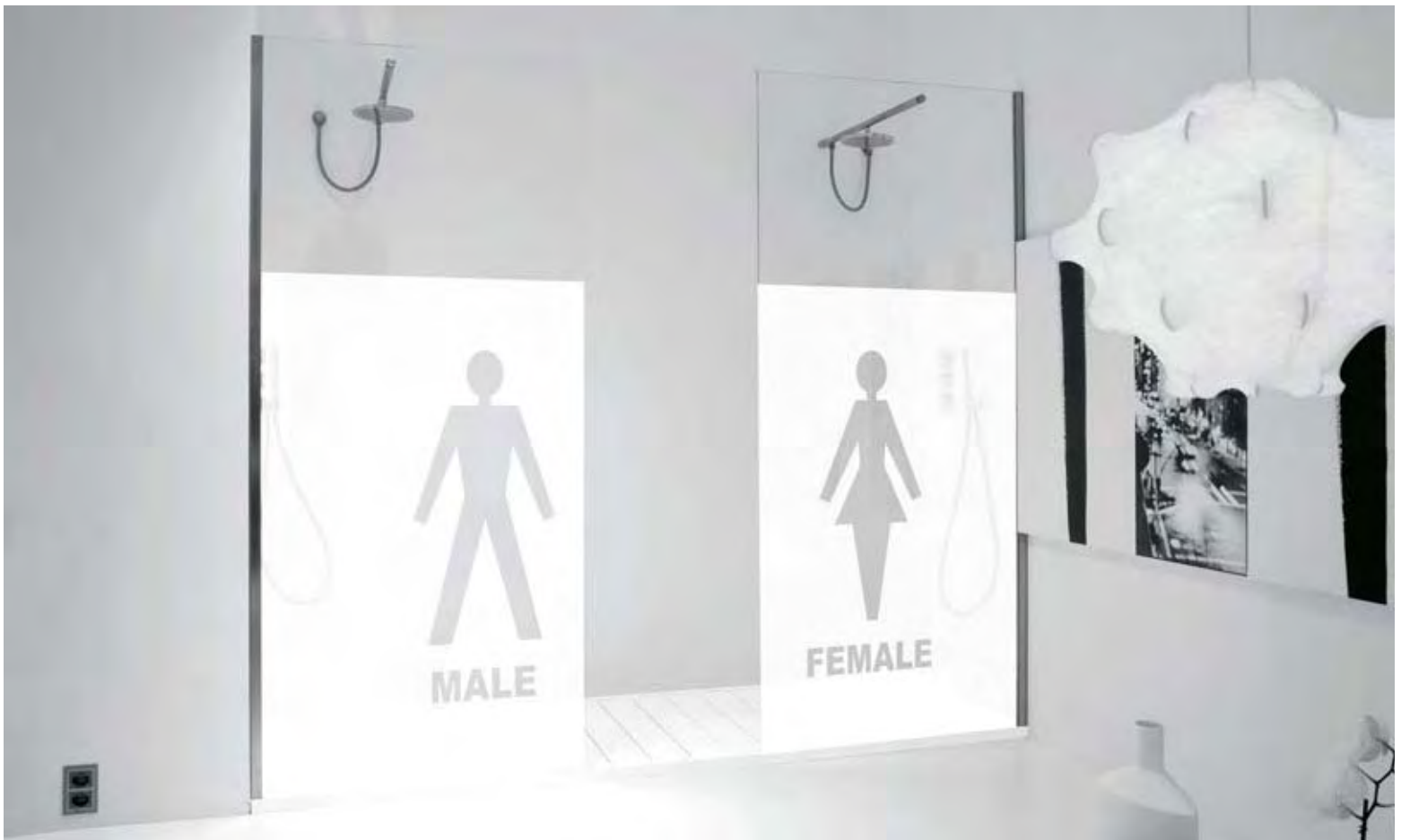



art. MALE/P

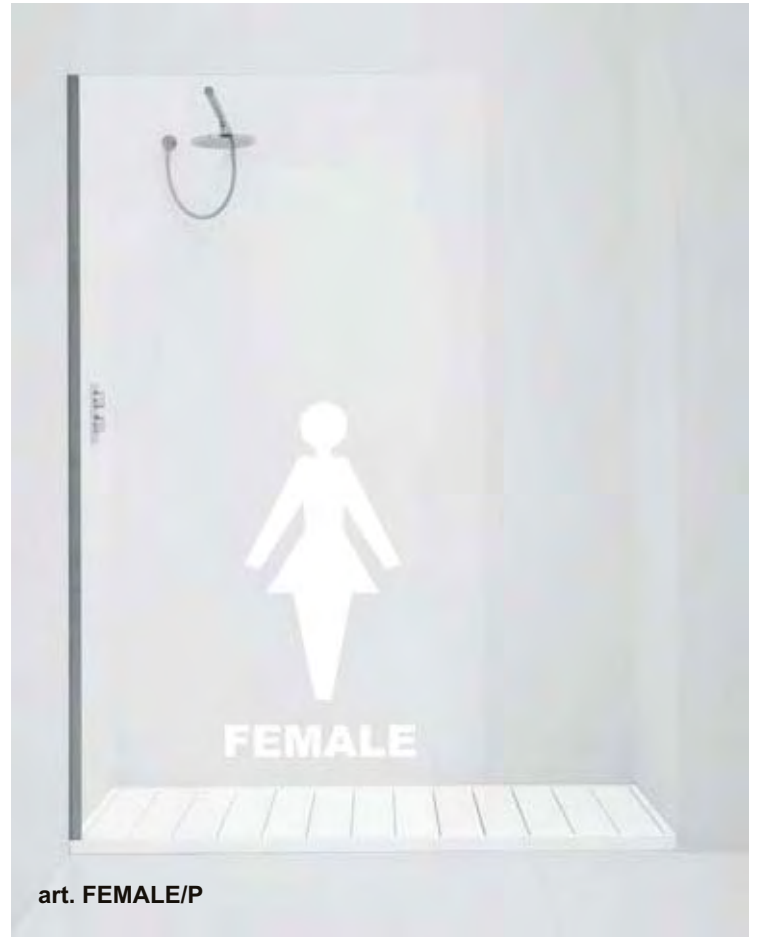

art. FEMALE/P







art. SHAKESPEARE/N



art. SHAKESPEARE/P



art. JAP/N



art. JAP/P



art. LABELLEZZA/N



art. LABELLEZZA/P



art. YAB/N

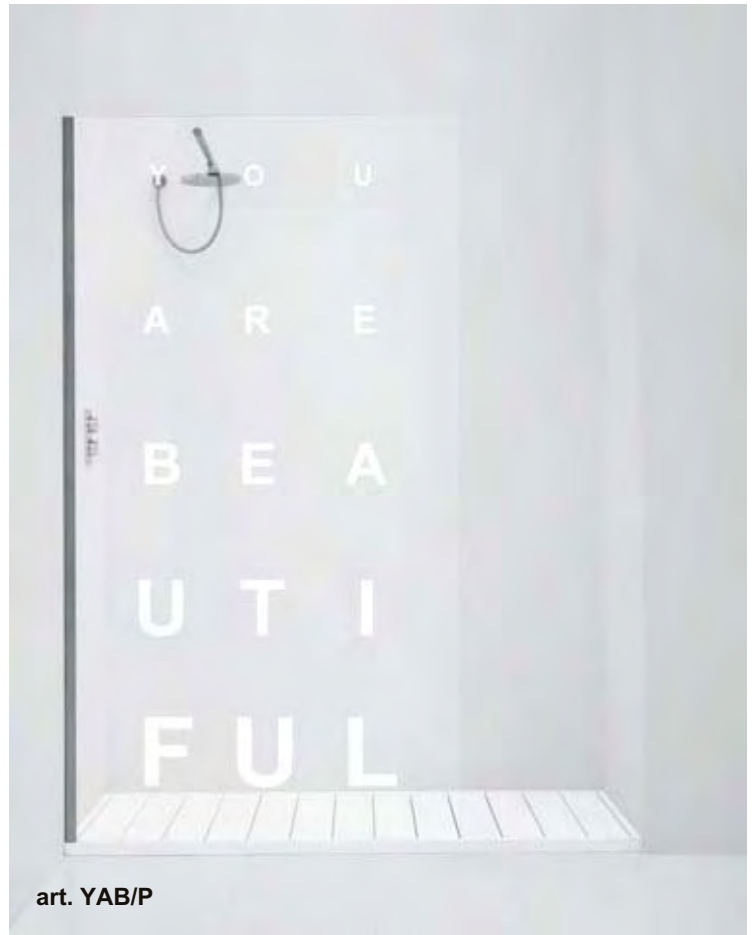

art. YAB/P



piatti e box doccia
trays and shower enclosures



piatti e box doccia
193



1 2 3 4
5 6 7 8
9 0

art. PITAGORA/P numero 8

1 2 3 4
5 6 7 8
9 0



piatti e box doccia
trays and shower enclosures

art. PITAGORA/N numero 6

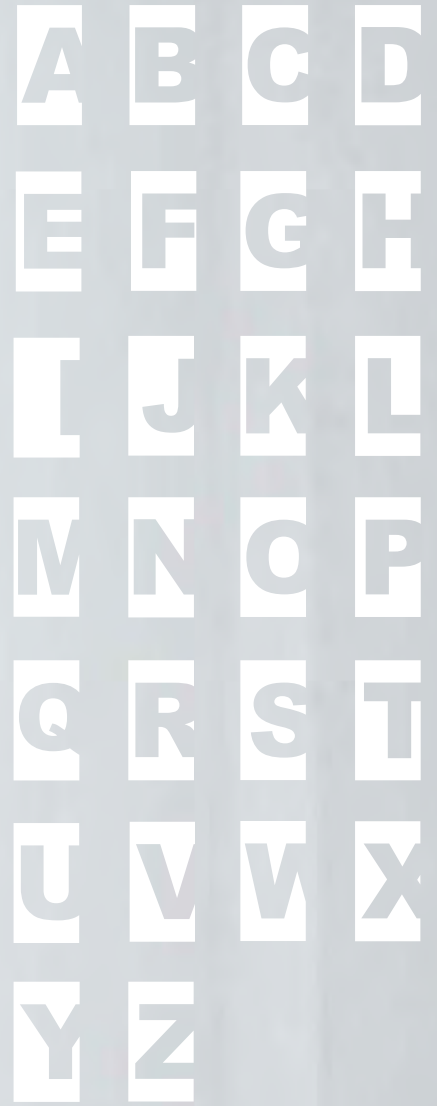

art. ALFABETO/N lettera R

A B C D
E F G H
I J K L
M N O P
Q R S T
U V W X
Y Z



piatti e box doccia
trays and shower enclosures



LA *Noi.*
TERRA *siamo*
HA *fatti* **UNA**
IL *della* **MUSICA**
stessa **RESTO**
PER *materia*
BELLA **PRIGIONE,**
È *dei* **IL**
sogni
COLORO **MONDO** CHE
SILENZIO
ASCOLTANO





piatti e box doccia
trays and shower enclosures



art. FIORITO1/P sx



art. FIORITO2/N dx